

Wichita

Model # WC.214.00

2-Compartment Industrial Sink

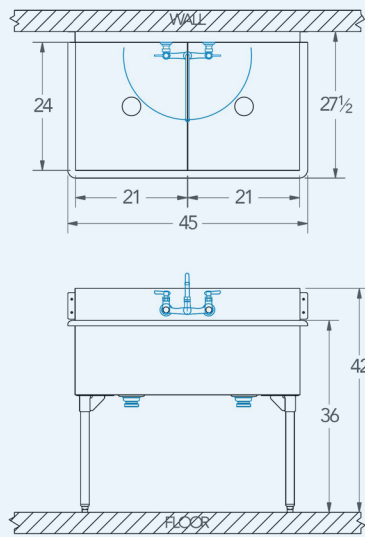

Bowl (Lg x Wd x Dp)

21" x 24" x 14"

Drainboard

Left: 0"

Right: 0"

Overall (Lg x Wd x Ht)

45" x 27 1/2" x 42"

Material

14 gauge, stainless steel

Faucet Holes

1-1/8" Dia 8" Centers

Drain

3-1/2" Dia Opening

Included:



Matched Faucet



Basket Drain(s)



Install Kit

Additional Features

- 14 gauge stainless steel
- 12 gauge partition(s)
- 14" deep to sink rim
- Robust retro styling
- Stainless steel legs & feet
- 1-1/2" sanitary rolled-rim
- D 3-1/2" recessed drain opening
- Integrated security flange
- Specification grade hardware included
- 10-year warranty
- Made in Texas